

EMI滤波器 LFA、LFB、LFH、LZA系列 EMI FILTERS LFA, LFB, LFH, LZA SERIES

推荐焊盘布局 Recommended land pattern.
印刷电路板设计 Board design

1.LZA05, LZA10

回流焊接 Reflow soldering

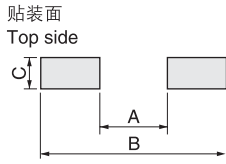

单位:mm Unit:mm

型号 Type	LZA05	LZA10
形状 Size	1.0×0.5	1.6×0.8
A	0.4	0.7
B	1.4	2.0
C	0.5	0.7

2.LCA10, LFA10

回流焊接 Reflow soldering

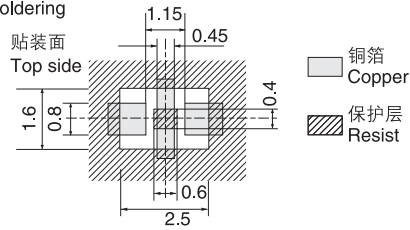

单位:mm Unit:mm

型号 Type	LCA10	LFA10
形状 Size	1.6×0.8	1.6×0.8
A	1.15	1.15
B	0.45	0.45
C	1.6	1.6
D	0.8	0.8
E	2.5	2.5
F	0.6	0.6
G	0.4	0.4

①建议经通孔连接到地线(LFA10)
Connection to ground pattern via through hole recommended (LFA10)

3.LCA20, LFA20, LFB20, LFA30, LFB30

回流焊接 Reflow soldering

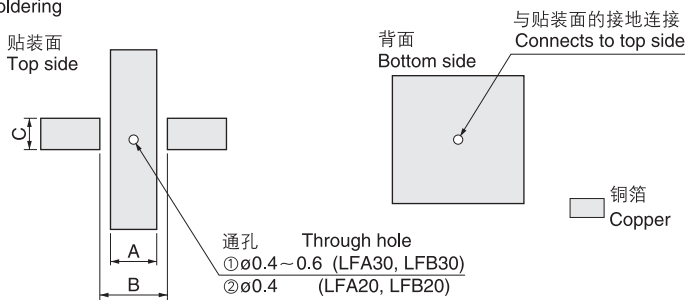

单位:mm Unit:mm

型号 Type	LCA20	LFA20 LFB20	LFA30 LFB30
形状 Size	2.0×1.25	2.0×1.25	3.2×1.6
A	0.6	0.6	1.3
B	1.5	1.5	2.3
C	1.0	1.0	1.3

流动焊接 Flow soldering

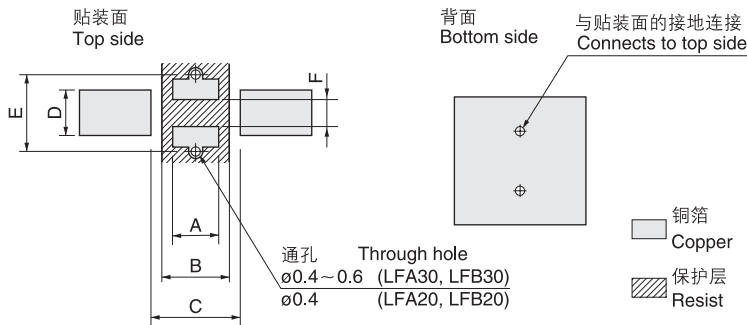

单位:mm Unit:mm

型号 Type	LCA20	LFA20 LFB20	LFA30 LFB30
形状 Size	2.0×1.25	2.0×1.25	3.2×1.6
A	0.6	0.6	1.3
B	0.8	0.8	1.5
C	1.5	1.5	2.3
D	1.0	1.0	1.3
E	2.2	2.2	3.0
F	0.6	0.6	0.6

4.LCA14, LFA24, LFH24, LCA24, LFA34

回流焊接 Reflow soldering

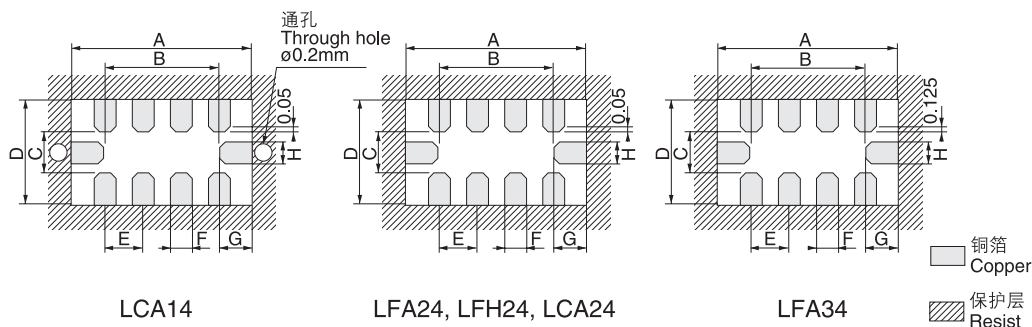

单位:mm Unit:mm

型号 Type	LCA14	LFA24 LCA24	LFH24	LFA34
形状 Size	1.6×0.8	2.0×1.25	2.0×1.0	3.2×1.6
A	2.2	2.6	2.6	3.8
B	1.2	1.5	1.5	2.5
C	0.5	0.75	0.63	0.9
D	1.4	1.85	1.73	2.6
E	0.4	0.5	0.5	0.8
F	0.15	0.25	0.25	0.45
G	0.5	0.55	0.55	0.65
H	0.15	0.23	0.23	0.45

CMB12系列是小型、薄型的高性能滤波器，适用于移动电话及移动音响设备等音频信号线的降噪。采用全陶瓷结构，粘接强度高、贴装可靠性优异，特别适用于便携式设备的音频信号线。

The audio line filter, CMB12 series, are small-sized and highly effective to noise filtering for the audio lines for mobile phones and portable audio equipments. It is suitable for audio lines of mobile equipments, because monolithic construction of ceramic realizes excellent adherence strength of terminations and high reliability in mounting.

规格

- 形状: 1210(1.25×1.0mm)
- 额定电流: 500mA, 400mA, 100mA
- 额定电压: 5V DC
- 开放模式阻抗: 120, 150, 800, 1200Ω

Specification

- Dimension: 1210(1.25×1.0mm)
- Rated current: 100mA
- Open mode Impedance: 120, 150, 800, 1200Ω
- Rated voltage: 5V DC

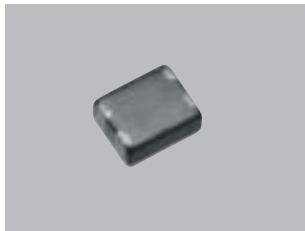

型号构成 Part number system

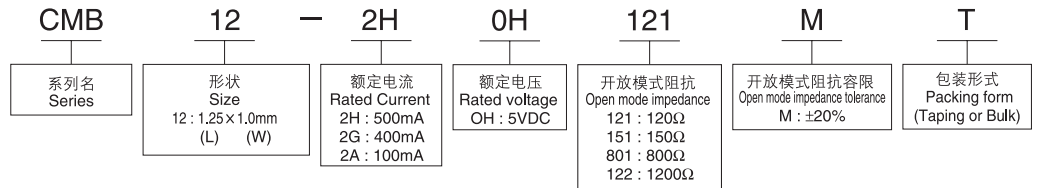

形状·尺寸(mm) Dimensions (mm)

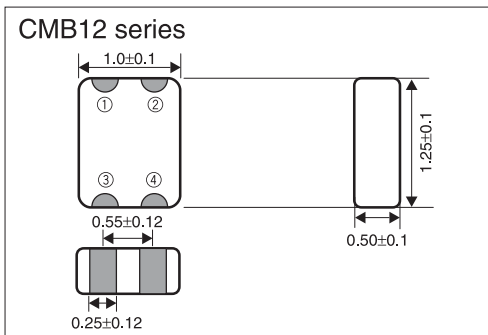

推荐焊盘布局 Recommended Land Pattern

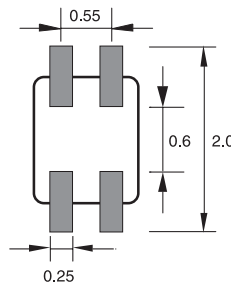

等效电路 Equivalent circuits

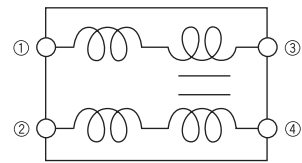

型号一览表 Part number list

型号 Part number	开放模式阻抗 Open mode impedance (Ω:100MHz)	额定电压 Rated voltage	额定电流 Rated current	绝缘电阻 Insulation Resistance
CMB12-2H0H121M	120Ω	5V	500mA	100MΩmin.
CMB12-2G0H151M	150Ω		400mA	
CMB12-2A0H801M	800Ω		100mA	
CMB12-2A0H122M	1200Ω			

阻抗特性(参考) Impedance Characteristics (Reference)

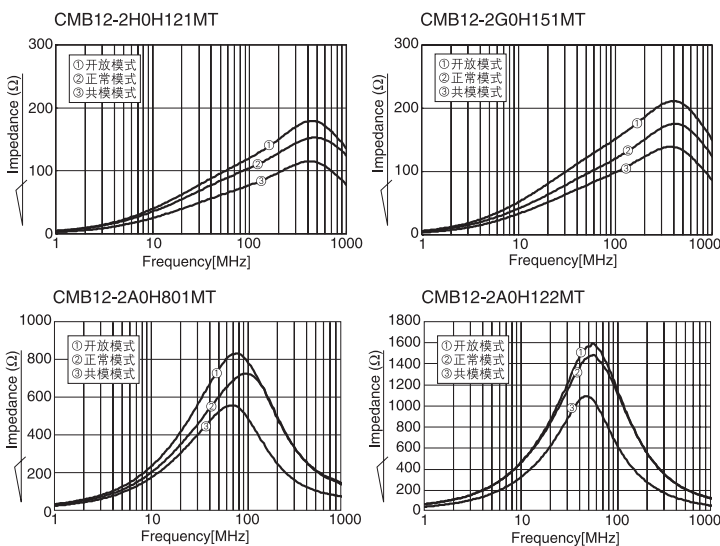

测量电路 Measuring Circuit

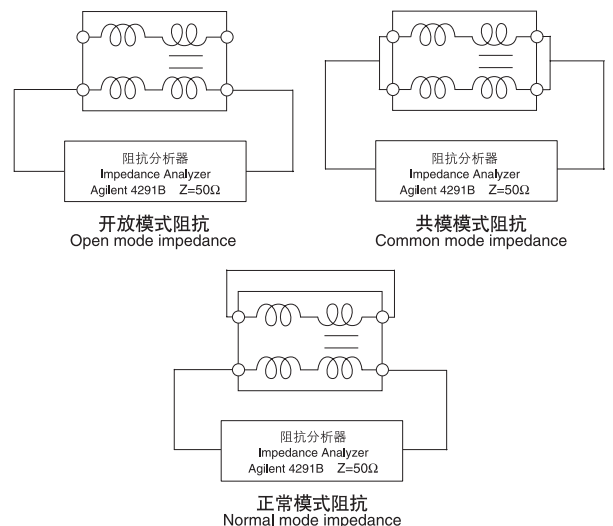

EMI滤波器 EMI FILTERS

单位: mm
Unit: mm

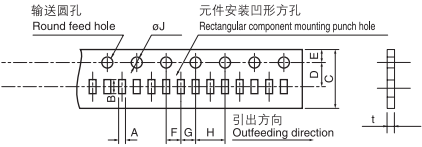
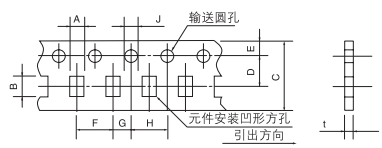
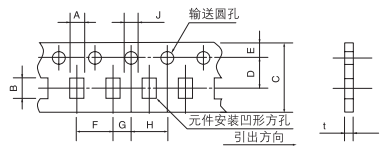
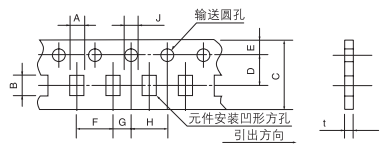
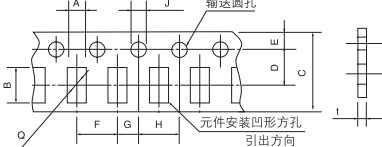
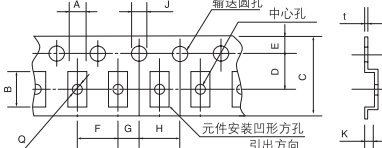
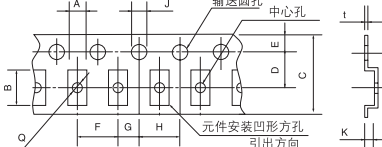
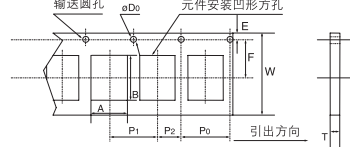
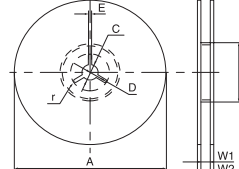
包装记号 Packing code	对应系列 Related series	包装数量 Packing Qty.	包装形式 Packing form																							
B	所有型号 All types	500	聚乙烯袋 Poly bag 																							
T	LZA05	10,000	 <table border="1" data-bbox="1037 481 1460 627"> <tr><td>A</td><td>B</td><td>C</td><td>D</td><td>E</td></tr> <tr><td>0.62 ±0.10</td><td>1.15 ±0.10</td><td>8.0 ±0.3</td><td>3.50 ±0.05</td><td>1.75 ±0.10</td></tr> <tr><td>F</td><td>G</td><td>H</td><td>J</td><td>t</td></tr> <tr><td>2.0 ±0.1</td><td>2.00 ±0.05</td><td>4.0 ±0.1</td><td>ø1.5 +0.1 -0</td><td>0.8 以下 max</td></tr> </table>	A	B	C	D	E	0.62 ±0.10	1.15 ±0.10	8.0 ±0.3	3.50 ±0.05	1.75 ±0.10	F	G	H	J	t	2.0 ±0.1	2.00 ±0.05	4.0 ±0.1	ø1.5 +0.1 -0	0.8 以下 max			
	A	B	C	D	E																					
	0.62 ±0.10	1.15 ±0.10	8.0 ±0.3	3.50 ±0.05	1.75 ±0.10																					
	F	G	H	J	t																					
	2.0 ±0.1	2.00 ±0.05	4.0 ±0.1	ø1.5 +0.1 -0	0.8 以下 max																					
	LCA10 LFA10 LCA14	4,000	 <table border="1" data-bbox="1037 660 1460 806"> <tr><td>A</td><td>B</td><td>C</td><td>D</td><td>E</td></tr> <tr><td>1.00 ±0.05</td><td>1.8 ±0.05</td><td>8.0 ±0.2</td><td>3.50 ±0.05</td><td>1.75 ±0.1</td></tr> <tr><td>F</td><td>G</td><td>H</td><td>J</td><td>t</td></tr> <tr><td>4.0 ±0.1</td><td>2.00 ±0.05</td><td>4.0 ±0.1</td><td>1.50^{+0.1}₋₀</td><td>0.7 ±0.1</td></tr> </table>	A	B	C	D	E	1.00 ±0.05	1.8 ±0.05	8.0 ±0.2	3.50 ±0.05	1.75 ±0.1	F	G	H	J	t	4.0 ±0.1	2.00 ±0.05	4.0 ±0.1	1.50 ^{+0.1} ₋₀	0.7 ±0.1			
	A	B	C	D	E																					
1.00 ±0.05	1.8 ±0.05	8.0 ±0.2	3.50 ±0.05	1.75 ±0.1																						
F	G	H	J	t																						
4.0 ±0.1	2.00 ±0.05	4.0 ±0.1	1.50 ^{+0.1} ₋₀	0.7 ±0.1																						
LZA10	4,000	 <table border="1" data-bbox="1037 840 1460 985"> <tr><td>A</td><td>B</td><td>C</td><td>D</td><td>E</td></tr> <tr><td>0.95 ±0.2</td><td>1.8 ±0.2</td><td>8.0 ±0.3</td><td>3.50 ±0.05</td><td>1.75 ±0.1</td></tr> <tr><td>F</td><td>G</td><td>H</td><td>J</td><td>t</td></tr> <tr><td>4.0 ±0.1</td><td>2.00 ±0.05</td><td>4.0 ±0.1</td><td>1.50^{+0.1}₋₀</td><td>1.1以下</td></tr> </table>	A	B	C	D	E	0.95 ±0.2	1.8 ±0.2	8.0 ±0.3	3.50 ±0.05	1.75 ±0.1	F	G	H	J	t	4.0 ±0.1	2.00 ±0.05	4.0 ±0.1	1.50 ^{+0.1} ₋₀	1.1以下				
A	B	C	D	E																						
0.95 ±0.2	1.8 ±0.2	8.0 ±0.3	3.50 ±0.05	1.75 ±0.1																						
F	G	H	J	t																						
4.0 ±0.1	2.00 ±0.05	4.0 ±0.1	1.50 ^{+0.1} ₋₀	1.1以下																						
LCA20 LFA20 LFB20 LFA24 LCA24	4,000	 <table border="1" data-bbox="1037 1019 1460 1164"> <tr><td>A</td><td>B</td><td>C</td><td>D</td><td>E</td></tr> <tr><td>1.62 ±0.2</td><td>2.4 ±0.2</td><td>8.0 ±0.3</td><td>3.5 ±0.05</td><td>1.75 ±0.1</td></tr> <tr><td>F</td><td>G</td><td>H</td><td>J</td><td>t</td></tr> <tr><td>4.0 ±0.1</td><td>2.0 ±0.05</td><td>4.0 ±0.1</td><td>1.50^{+0.1}₋₀</td><td>1.05 ±0.1</td></tr> </table>	A	B	C	D	E	1.62 ±0.2	2.4 ±0.2	8.0 ±0.3	3.5 ±0.05	1.75 ±0.1	F	G	H	J	t	4.0 ±0.1	2.0 ±0.05	4.0 ±0.1	1.50 ^{+0.1} ₋₀	1.05 ±0.1				
A	B	C	D	E																						
1.62 ±0.2	2.4 ±0.2	8.0 ±0.3	3.5 ±0.05	1.75 ±0.1																						
F	G	H	J	t																						
4.0 ±0.1	2.0 ±0.05	4.0 ±0.1	1.50 ^{+0.1} ₋₀	1.05 ±0.1																						
LFH24	4,000	 <table border="1" data-bbox="1037 1198 1460 1344"> <tr><td>A</td><td>B</td><td>C</td><td>D</td><td>E</td></tr> <tr><td>1.20 ±0.08</td><td>2.20 ±0.08</td><td>8.0 ±0.2</td><td>3.50 ±0.05</td><td>1.75 ±0.10</td></tr> <tr><td>F</td><td>G</td><td>H</td><td>J</td><td>t</td></tr> <tr><td>4.0 ±0.1</td><td>2.00 ±0.05</td><td>4.0 ±0.1</td><td>1.50^{+0.1}₋₀</td><td>1.00 ±0.10</td></tr> </table>	A	B	C	D	E	1.20 ±0.08	2.20 ±0.08	8.0 ±0.2	3.50 ±0.05	1.75 ±0.10	F	G	H	J	t	4.0 ±0.1	2.00 ±0.05	4.0 ±0.1	1.50 ^{+0.1} ₋₀	1.00 ±0.10				
A	B	C	D	E																						
1.20 ±0.08	2.20 ±0.08	8.0 ±0.2	3.50 ±0.05	1.75 ±0.10																						
F	G	H	J	t																						
4.0 ±0.1	2.00 ±0.05	4.0 ±0.1	1.50 ^{+0.1} ₋₀	1.00 ±0.10																						
LFA30 LFB30	2,000	 <table border="1" data-bbox="1037 1377 1460 1523"> <tr><td>A</td><td>B</td><td>C</td><td>D</td><td>E</td><td>F</td></tr> <tr><td>1.9 ±0.2</td><td>3.5 ±0.2</td><td>8.0 ±0.3</td><td>3.5 ±0.05</td><td>1.75 ±0.1</td><td>4.0 ±0.1</td></tr> <tr><td>G</td><td>H</td><td>J</td><td>K</td><td>t</td><td>Q</td></tr> <tr><td>2.0 ±0.05</td><td>4.0 ±0.1</td><td>1.55 ±0.1</td><td>1.20 ±0.2</td><td>0.25 ±0.05</td><td>1.15 ±0.05</td></tr> </table>	A	B	C	D	E	F	1.9 ±0.2	3.5 ±0.2	8.0 ±0.3	3.5 ±0.05	1.75 ±0.1	4.0 ±0.1	G	H	J	K	t	Q	2.0 ±0.05	4.0 ±0.1	1.55 ±0.1	1.20 ±0.2	0.25 ±0.05	1.15 ±0.05
A	B	C	D	E	F																					
1.9 ±0.2	3.5 ±0.2	8.0 ±0.3	3.5 ±0.05	1.75 ±0.1	4.0 ±0.1																					
G	H	J	K	t	Q																					
2.0 ±0.05	4.0 ±0.1	1.55 ±0.1	1.20 ±0.2	0.25 ±0.05	1.15 ±0.05																					
LFA34	2,000	 <table border="1" data-bbox="1037 1556 1460 1702"> <tr><td>A</td><td>B</td><td>C</td><td>D</td><td>E</td><td>F</td></tr> <tr><td>1.9 ±0.2</td><td>3.5 ±0.2</td><td>8.0 ±0.3</td><td>3.5 ±0.05</td><td>1.75 ±0.1</td><td>4.0 ±0.1</td></tr> <tr><td>G</td><td>H</td><td>J</td><td>K</td><td>t</td><td>Q</td></tr> <tr><td>2.0 ±0.05</td><td>4.0 ±0.1</td><td>1.50^{+0.1}₋₀</td><td>1.0 ±0.2</td><td>0.25 ±0.05</td><td>1.0^{+0.1}₋₀</td></tr> </table>	A	B	C	D	E	F	1.9 ±0.2	3.5 ±0.2	8.0 ±0.3	3.5 ±0.05	1.75 ±0.1	4.0 ±0.1	G	H	J	K	t	Q	2.0 ±0.05	4.0 ±0.1	1.50 ^{+0.1} ₋₀	1.0 ±0.2	0.25 ±0.05	1.0 ^{+0.1} ₋₀
A	B	C	D	E	F																					
1.9 ±0.2	3.5 ±0.2	8.0 ±0.3	3.5 ±0.05	1.75 ±0.1	4.0 ±0.1																					
G	H	J	K	t	Q																					
2.0 ±0.05	4.0 ±0.1	1.50 ^{+0.1} ₋₀	1.0 ±0.2	0.25 ±0.05	1.0 ^{+0.1} ₋₀																					
CMB12	4,000	 <table border="1" data-bbox="1037 1736 1460 1881"> <tr><td>A</td><td>B</td><td>W</td><td>F</td><td>E</td></tr> <tr><td>1.20 ±0.2</td><td>1.45 ±0.05</td><td>8.0 ±0.2</td><td>3.50 ±0.05</td><td>1.75 ±0.10</td></tr> <tr><td>P₁</td><td>P₂</td><td>P₀</td><td>D₀</td><td>T</td></tr> <tr><td>4.0 ±0.1</td><td>2.00 ±0.05</td><td>4.0 ±0.1</td><td>ø1.5^{+0.1}₋₀</td><td>0.68 ±0.05</td></tr> </table>	A	B	W	F	E	1.20 ±0.2	1.45 ±0.05	8.0 ±0.2	3.50 ±0.05	1.75 ±0.10	P ₁	P ₂	P ₀	D ₀	T	4.0 ±0.1	2.00 ±0.05	4.0 ±0.1	ø1.5 ^{+0.1} ₋₀	0.68 ±0.05				
A	B	W	F	E																						
1.20 ±0.2	1.45 ±0.05	8.0 ±0.2	3.50 ±0.05	1.75 ±0.10																						
P ₁	P ₂	P ₀	D ₀	T																						
4.0 ±0.1	2.00 ±0.05	4.0 ±0.1	ø1.5 ^{+0.1} ₋₀	0.68 ±0.05																						
所有型号 All types			 <table border="1" data-bbox="909 1915 1460 2016"> <tr><td>记号Code</td><td>A</td><td>B</td><td>C</td><td>D</td><td>E</td><td>W₁</td><td>W₂</td><td>r</td></tr> <tr><td>RRM08B</td><td>ø180.0⁺⁰₋₃</td><td>ø60⁺¹₋₀</td><td>ø13.0 ±0.2</td><td>R10.5 ±0.4</td><td>2.0 ±0.5</td><td>9.0 ±0.3</td><td>11.4 ±1.0</td><td>0.5</td></tr> </table>	记号Code	A	B	C	D	E	W ₁	W ₂	r	RRM08B	ø180.0 ⁺⁰ ₋₃	ø60 ⁺¹ ₋₀	ø13.0 ±0.2	R10.5 ±0.4	2.0 ±0.5	9.0 ±0.3	11.4 ±1.0	0.5					
记号Code	A	B	C	D	E	W ₁	W ₂	r																		
RRM08B	ø180.0 ⁺⁰ ₋₃	ø60 ⁺¹ ₋₀	ø13.0 ±0.2	R10.5 ±0.4	2.0 ±0.5	9.0 ±0.3	11.4 ±1.0	0.5																		

EMI FILTER